

U-Bracket Speaker Mount

Installation Instructions UB-0950

This U-Bracket attaches one loudspeaker to a wall, deck, ceiling, or balcony and provides an aiming feature.

Warning:

Mounting and/or rigging loudspeakers requires experienced professionals. ***Improperly installed loudspeakers can result in property damage, personal injury, death and/or liability to the installing contractor.***

Note to Contractor: Due to the wide variety of wall structures, materials and methods, these instructions assume that the contractor will exercise good judgment in selecting the proper mounting area and hardware. Do not rely on drywall, acoustic tiles, etc. to support the weight of any loudspeaker.



To assure a trouble free installation, read through and follow these instructions carefully before beginning. If you have doubts about the integrity of the structure you are mounting to, or you are not sure about the proper hardware to use, consult a structural and/or hardware specialist. As a guide, when complete, the installation should be capable of supporting between 5 to 10 times the actual applied load. The use of a back up safety system, such as a safety cable, is highly recommended. Standard safety cables are available from stock.

Contents:	U- Bracket Speaker Mount	2 pcs.	Hardware kit	2 pcs.
	Instruction Sheet	1 pc.		

Step 1. Place the U-Bracket over the speaker cabinet to be sure you have the correct mount. Sound isolation gaskets are placed between the loudspeaker cabinet and the U-Bracket's arms and fill any gaps, up to 3/8" per side. Also, compare the included assembly hardware with that of the loudspeaker. If threaded mounting points are not provided by the manufacturer contact them for the correct mounting procedure.

Step 2. Select the mounting area where the loudspeaker will be installed. Attach the base of the U-Bracket to the wall or ceiling using the appropriate hardware for the application (if in doubt, consult a local hardware specialist). Tighten permanently.

Step 3. Place the speaker between the U-Bracket's arms. Insert a hex bolt, flat washer and lock washer (must match the speaker's thread) through the desired slot in one of the arms with the sound isolation gasket, (select either a 1/8", 1/4" thick or both per end), threading the bolt into the loudspeaker. Repeat on the other side of the speaker. (See figure 1) Do not fully tighten yet.

Step 4. Rotate the loudspeaker into the desired direction then tighten the side bolts permanently. To permanently set the speaker angle, insert the included lag bolts through the unused arm slots and into the loudspeaker cabinet. (See figure 2)

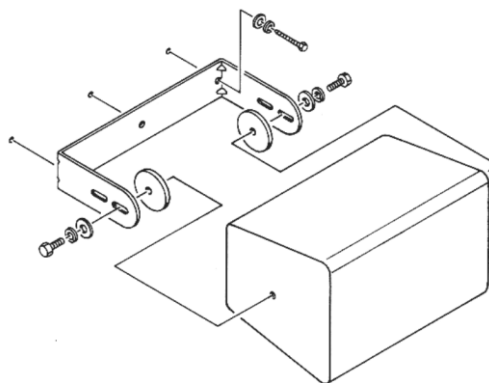

Figure 1

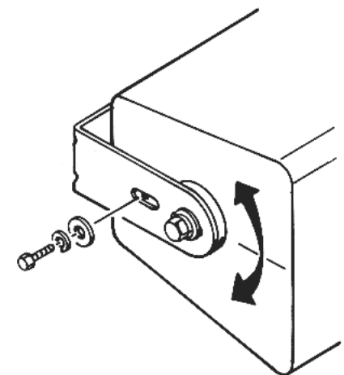

Figure 2

Step 5. **Recommendation: Safety Cable**
Install a safety cable to the U-Bracket and to the mounting surface.